



## PC284T-25-4

### CONVERTER

DESIGNED FOR USE WITH ROTARY PHASE CONVERTER UNITS

TOTALLY ENCLOSED FAN COOLED

SPIKE RESISTANT WIRE (2200V PEAK VOLTAGE SPIKE RATING)

Factory Certified for T2B Class I, Division II, Groups A,B,C & D and Class II, Division II, Groups F & G

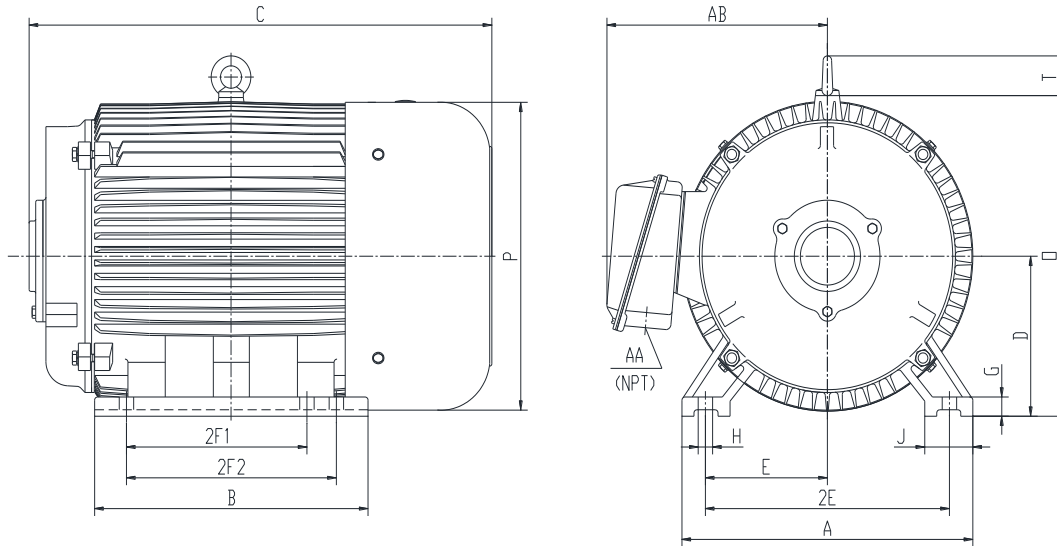

### DIMENSIONS

HP	RPM	Frame	MOUNTING													
			A	B	C	D	G	H	J	E	2E	2F1	2F2	O	P	T
25	1800	284T	14	11.7	21.8	7	0.85	0.53	2.75	5.5	11	9.5	NA	14.5	14	2.2

Conduit Box		Bearings		Mount
AA	AB	DE	ODE	
1.5	11.3	6311	6311	F1

**BEARING LUBRICATION:** The bearings come lubricated with Mobil Polyrex EM Polyurea Grease. It is recommended that you add some additional lubrication when the motor is installed.

Three options (brands) for suitable lubrication include, but are not limited to, the following:

- 1.) Mobil Polyrex EM
- 2.) Citco Polyurea MP
- 3.) Conoco Phillips Polytac EP





## PC284T-25-4

### CONVERTER

DESIGNED FOR USE WITH ROTARY PHASE CONVERTER UNITS

TOTALLY ENCLOSED FAN COOLED

SPIKE RESISTANT WIRE (2200V PEAK VOLTAGE SPIKE RATING)





Factory Certified for T2B Class I, Division II, Groups A,B,C & D and Class II, Division II, Groups F & G

### PERFORMANCE DATA

HP	RPM	Frame	Voltage	Frequency (Hz)	Full Load S.F.	Insulation Class	NEMA Design	Slip (%)	NEMA Code	Enclosure Type	IP Rating	Max. Ambient
25	1770	284T	208-230/460	60	1.15	F	B	1.7	G	TEFC	55	40 °C

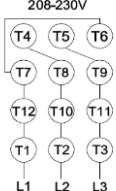
Amps (460V)			Efficiency (%)		Power Factor	Torque (ft-lb)			DE Bearing	ODE Bearing	Connection	Weight (lbs.)
FLA	LRA	NOM.	MIN.	100%	FLT	LRT %	BDT %					
30	182	91.0	89.5	0.87	74.3	200	280	6311	6311	12 Lead 2Δ/Δ	365	

### NAME PLATE

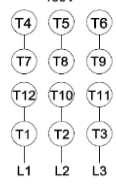
 <b>ROTARY PHASE CONVERTER</b> INVERTER DUTY 20:1 VT; 10:1 CT      Hernando, MS 38632										<b>CONNECTION DIAGRAMS</b> 208-230V 	
CAT NO.		PC284T-25-4				FRAME		284T	WT/LBS		365
HZ	60	S.F.	1.15	HZ	50	S.F.	1.0	ENCL	TEFC	IP	55
HP	25	RPM	1800	HP	25	RPM	1500	DUTY	CONT	DES	B
VOLTS		208-230/460		VOLTS		190/380		AMB	40 °C	INS	F
AMPS		65-60/30		AMPS		70/35		BRG DE/ODE		6311/6311	
CODE	G	P.F.	0.87	CODE	F	P.F.	0.89	LUB: Mobil Polyrex EM			
EFF	91.0	MIN	89.5	EFF	88.5	MIN	85.5	SER NO			
				AC INDUCTION CONVERTER							
										460V 	

### APPLICATIONS:

Specifically designed for use as the converter component for rotary phase converters.